



# LINPAC

ROPAK™ reusable container system solutions



# ROPAK™ reusable collapsible containers: your supply chain advantage

## Maximize Your Efficiencies with ROPAKs

ROPAK reusable containers from LINPAC Materials Handling are designed to meet your standards for your diverse manufacturing or distribution needs. ROPAK reusable containers allow you to streamline the flow of material into, through, and out of your plant, maximizing your time, space and labor efficiencies. LINPAC makes your unique operations optimally productive and profitable at the same time.

***No other materials handling company can match our commitment to meeting your needs...***

## The Many Benefits of ROPAK Container Systems

- ❑ ROPAK containers facilitate mechanical and air conveyance of material, effectively reducing or replacing capital equipment costs of tilters and metal surge bins.
- ❑ Dependable ROPAKs withstand years of repeated handling and vehicle wear.
- ❑ Unlike wood, metal or cardboard cartons and super-sacks, ROPAK containers stack high to conserve as much of your valuable floor space as possible.
- ❑ Designed to reduce packaging and shipping costs, ROPAKs also provide superior product protection.
- ❑ Constructed of high-density polyethylene (HDPE), ROPAKs are tough, and offer long-lasting durability.
- ❑ ROPAKs prevent material contamination that commonly occurs with cardboard and metal container use.
- ❑ Cumulative costs for the disposal of cardboard cartons are eliminated with the use of ROPAKs.
- ❑ By collapsing to a fraction of their height in seconds, ROPAKs allow for space-saving storage and return shipment. They stack perfectly and safely, whether upright or collapsed, to maximize warehouse space without the use of racking.
- ❑ At the end of their useful lives, ROPAKs are easily recyclable.

## ROPAKs Withstand Rigorous Product Testing

To confirm that ROPAK containers, pallets and covers are the best available, LINPAC has invested heavily in a state-of-the-art testing facility. Routinely conducting competitive performance tests and thoroughly evaluating every model ensures that our container systems will exceed your expectations. We guarantee that LINPAC Materials Handling products will continue to meet your most demanding material handling needs today and for years to come.



## Your Satisfaction is Guaranteed

LINPAC stands behind every product we manufacture. That's why every purchase you make is covered by a unique 3-year limited warranty on all ROPAK reusable containers. With the best interests of the environment in mind, we also buy back obsolete and/or scrap ROPAK containers and any associated HDPE components. Please call 1.800.442.4892 or visit our website, [www.LinpacMH.com](http://www.LinpacMH.com), for more information.

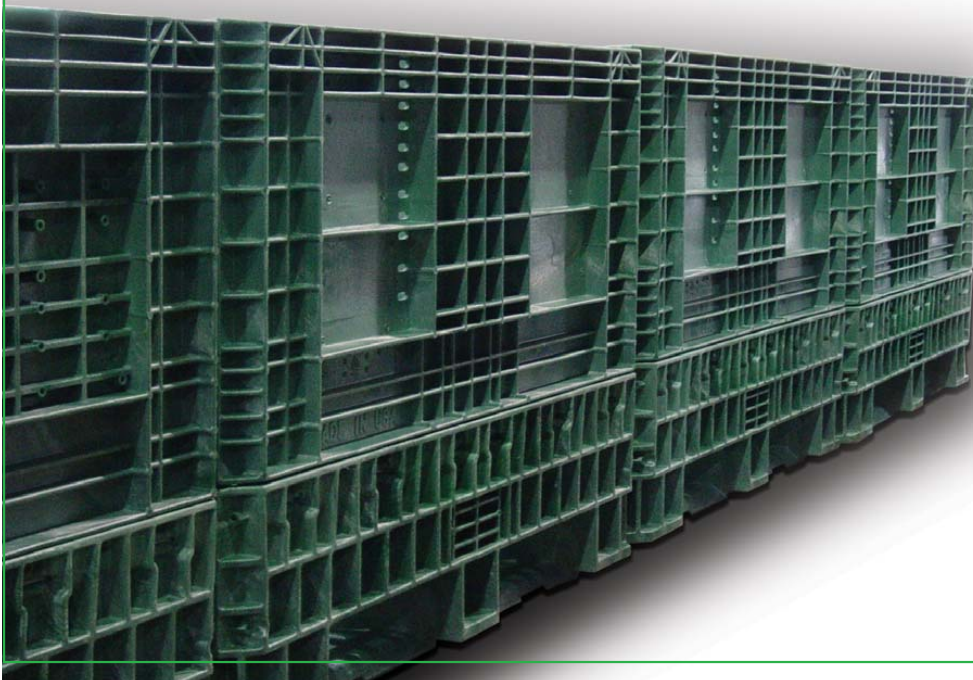

# a variety of sizes to best fit your needs

## Find the footprint that best suits your supply chain

ROPAK reusable containers are available in a wide range of standard footprints, ranging from 32" x 30" all the way to 78" x 48". Building on that solid foundation, ROPAKs are offered with a variety of sidewall heights and options, ranging from fixed to collapsible and solid, winged or with drop doors.

Some ROPAKs feature storage space for dunnage within the container after being collapsed. All have been engineered to offer you maximum return ratios for your application, with ergonomic features to help your employees work more productively and safely. A wide variety of accessories to maximize your productivity are also available.

Not sure which ROPAK model is best for your application? Give us a call and let one of our materials handling experts help you with your selection.

## ROPAK Reusable Container Specifications, by Size:

LINPAC Materials Handling Solutions	2
Customized reusable container solutions for a variety of industries	
ROPAK 3230	4
Compact and convenient, with one of the industry's best return ratios	
ROPAK 4048	6
The footprint most widely used in European applications	
ROPAK 4548	8
These heavy-duty containers are the best sellers in the ROPAK line	
ROPAK Industry Standard	10
For lighter- to medium-weight loads, a 48" x 45" footprint container	
ROPAK Hopper Bottom	11
Easily dispenses small, granular materials or uniformly shaped parts	
MAX <sup>3™</sup> 4448	12
Lighter-weight container features maximum cube efficiency and interior volume for shipping up to 20% more product	
ROPAK Fixed Wall Series	13
With rigid sidewalls atop a 48" x 45" footprint, for handling heavy parts	
ROPAK 5648 Extended Length	14
For oversized parts that won't fit easily into standard-sized containers	
ROPAK 6448 Extended Length	16
Offering superior size to accommodate super-sized components	
ROPAK 7048 Extended Length	18
An even longer dimension for storing and shipping even longer parts	
ROPAK 7848 Extended Length	20
The longest reusable, collapsible containers available for handling your challenging packaging needs	
ROPAK Pallets	21
Reusable plastic pallets offer an ecologically friendly alternative to wood	
ROPAK Ordering and Accessories	23
Everything you need to get the most from your container system	



These photos (1–4) show how easy it is to collapse ROPAK containers. All models are designed with speed and efficiency in mind.

# LINPAC Materials Handling

## global leader in reusable packaging solutions

### Solutions to the Most Difficult Challenges

Your supply chain challenges are unique and ever-changing. LINPAC Materials Handling offers solutions for all of your challenges, including:

- ❑ Reducing packaging costs
- ❑ Reducing packaging waste
- ❑ Increasing shipping densities
- ❑ Increasing product protection
- ❑ Meeting health and safety requirements
- ❑ Developing recycling programs
- ❑ Monitoring logistics systems through barcoding and RFID

You can count on our team of packaging solutions professionals to go to extraordinary lengths to ensure that ROPAKs are integrated into your distribution chain effectively and efficiently. Our experts will design a custom solution that fits your unique application, developing reusable packaging solutions that meet your exact needs.

Rely on LINPAC Materials Handling to provide you continual service with product, application and technical support to keep your supply chain operating at maximum efficiency.

### Business Cases

Because your situation is unique, we offer a personalized cost analysis service to help you determine your best solution.

### Leasing

Short-term rentals of 6 months or more, to longer leasing terms up to 5 years are available to best suit your handling needs.



### Dunnage Design

Unique, returnable dunnage can be created to protect your parts. LINPAC's experienced engineers can work with you to develop a dunnage prototype and produce interior dunnage that is customized for your unique parts or products.



For more information, please contact LINPAC Global Automotive Solutions at 248.619.0142.





**Global Resources**

When you work with LINPAC Materials Handling, you work with a member of one of the foremost international packaging and industrial organizations: the LINPAC Group of Companies. The LINPAC Group of companies is represented worldwide to provide you with the opportunity for truly global access to outstanding quality products.



**Repair**

Comprehensive repair and maintenance services are available. We provide repair contracts for replacement parts, on-site repairs, regular maintenance and upgrades.



**Skill, Dedication, Knowledge — True Expertise**

Offering both extensive knowledge and expertise in the packaging industry shows that ROPAK products have proven to be both extremely consistent and durable performers in a variety of industries. Let LINPAC Materials Handling tackle your supply chain challenge today.

3

**Recycling**

With the best interests of the environment in mind, LINPAC will buy back obsolete and/or scrap containers and any associated HDPE components for recycling.



Patented Design



**Fabrication**

LINPAC's containers are available in many standard sizes and drop door configurations. However, if special sizes or modifications are required, our engineers can design and fabricate containers to fit your special application.

**Sample Program**

Try it before you buy it. A container may be tested for up to 60 days, then either purchased or returned.



Patented Design

# ROPAK™ 3230

## maximum storage, minimum size

4



### ROPAK 3230 2-Way Fork Entry

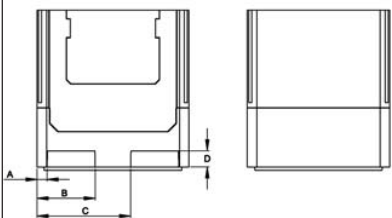

#### Conveyable Base

- A 2.13"/54.10 mm
- B 12.36"/313.99 mm
- C 19.89"/505.16 mm
- D 3.44"/87.33 mm

### ROPAK 3230 4-Way Fork Entry

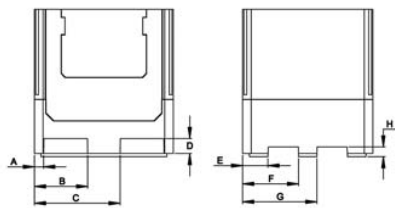

#### Non-Conveyable Base

- A 2.13"/54.10 mm
- B 12.36"/313.99 mm
- C 19.89"/505.16 mm
- D 3.44"/87.33 mm
- E 5.88"/149.23 mm
- F 13.00"/330.20 mm
- G 17.25"/438.15 mm
- H 2.25"/57.15 mm

### ROPAK 3230 CONTAINER SPECIFICATIONS

Part Number		3A18/3B18	3A25/3B25
Exterior Dimensions	length	32.3"/819 mm	32.3"/819 mm
	width	30.3"/768 mm	30.3"/768 mm
	height	18"/457 mm	25"/635 mm
Interior Dimensions	length	29.5"/749 mm	29.5"/749 mm
	width	27.4"/694 mm	27.4"/694 mm
	height	12.5"/317 mm	19.3"/490 mm
	height to fill line	11.5"/292 mm	18.3"/465 mm
Drop Door Options		N/A	0, 1, 2
32" Side Drop Door Dimensions	width	N/A	19.8"/503 mm
	height	N/A	11.3"/287 mm
Container Volume		5.4 ft <sup>3</sup> /0.15 m <sup>3</sup>	8.6 ft <sup>3</sup> /0.24 m <sup>3</sup>
Container Capacity		2000 lb/907 kg	2000 lb/907 kg
Stack Height	Static/Dynamic	6/5	6/4
Tare Weight (may vary)		50 lb/22.7 kg	65 lb/29 kg
Collapsed Height	Fixed Wall		13.2"/335 mm
Return Ratio		1:1	1.9:1
Truckload Quantity (Collapsed)	48' with cover/no cover	N/A	378/432
	53' with cover/no cover	N/A	420/480
Truckload Quantity (Open)	48' with cover/no cover	228/285	162/216
	53' with cover/no cover	240/300	180/240
40' ISO Container (Collapsed)	Std. with cover/no cover	N/A	252/294
	Hi Cube with cover/no cover	N/A	288/336
40' ISO Container (Open)	Std. with cover/no cover	168/210	108/126
	Hi Cube with cover/no cover	204/210	144/168

The 3A designation indicates a container with a Closed Deck. Open Deck containers are designated with the 3B code.

Additionally, two bases are available: A two-way forklift entry, conveyable model, and a four-way forklift entry model that is not conveyable. Please call Customer Service at 1.800.442.4892 for more information.

**32" x 30" Footprint ROPAK Reusable Containers are Perfect for:**

Automotive Components | Bearings | Hardware | Industrial Equipment | Metal Parts  
Plastics and Rubber | Resins and Powders | Stampings | Textiles | Tools

3A30/3B30	3A34/3B34	3A39/3B39
32.3"/819 mm	32.3"/819 mm	32.3"/819 mm
30.3"/768 mm	30.3"/768 mm	30.3"/768 mm
30"/762 mm	34"/864 mm	39"/990 mm
29.5"/749 mm	29.5"/749 mm	29.5"/749 mm
27.4"/694 mm	27.4"/694 mm	27.4"/694 mm
24.3"/617 mm	28.3"/719 mm	33.3"/846 mm
23.3"/592 mm	27.3"/694 mm	32.3"/820 mm
0, 1, 2	0, 1, 2	0, 1, 2
19.8"/503 mm	19.8"/503 mm	19.8"/503 mm
11.3"/287 mm	15.7"/399 mm	15.7"/399 mm
10.9 ft <sup>3</sup> /0.31 m <sup>3</sup>	12.8 ft <sup>3</sup> /0.36 m <sup>3</sup>	15.1 ft <sup>3</sup> /0.43 m <sup>3</sup>
2000 lb/907 kg	2000 lb/907 kg	2000 lb/907 kg
6/4	5/3	5/3
72 lb/32 kg	81 lb/37 kg	90 lb/41 kg
18.2"/462 mm	13.2"/335 mm	18.3"/462 mm
1.7:1	2.6:1	2.1:1
240/285	378/432	240/285
270/300	420/480	270/300
171/171	108/162	114/114
180/180	120/180	120/120
190/210	252/294	190/210
200/210	288/336	200/210
120/126	108/126	84/84
126/126	108/126	84/84



ROPAK 3A containers feature a Closed Deck, shown above.



ROPAK 3B containers feature an Open Deck, shown above.

5

All dimensions and specifications are approximate. Interior height dimensions measured from center. Tare weight will vary based on color, height, drop door configuration and deck options. Performance characteristics are based on uniform static loads and may be affected by concentrated loads and elevated temperatures. Label holder availability and options depend on container height. HDPE materials and workmanship guaranteed for 3 years.

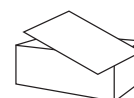

**Cover Available**

Please see page 24 of this catalog for the cover options offered for ROPAK 3230 containers.

# ROPAK™ 4048

## features the international footprint

6

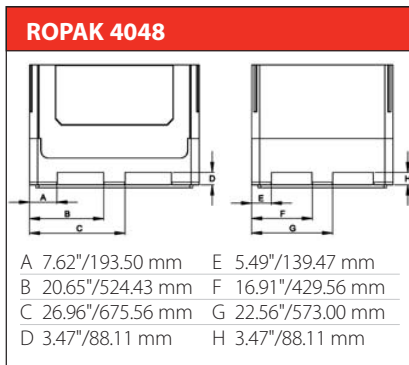

### ROPAK 4048 CONTAINER SPECIFICATIONS

		1016/1116	1025/1125
Part Number			
Exterior Dimensions	length	47.3"/1201 mm	47.3"/1201 mm
	width	39.6"/1006 mm	39.6"/1006 mm
	height	16.1"/409 mm	25.3"/643 mm
Interior Dimensions	length	43.6"/1107 mm	43.6"/1107 mm
	width	36"/914 mm	36"/914 mm
	height	10.3"/262 mm	19.6"/498 mm
	height to fill line	9.3"/236 mm	18.6"/472 mm
Drop Door Options		N/A	0, 1, 2
48" Side Drop Door Dimensions	width	N/A	32.7"/830 mm
	height	N/A	11.6"/294 mm
40" Side Drop Door Dimensions	width	N/A	N/A
	height	N/A	N/A
Container Volume		8.4 ft <sup>3</sup> /0.24 m <sup>3</sup>	17.0 ft <sup>3</sup> /0.48 m <sup>3</sup>
Container Capacity		2000 lb/907 kg	2000 lb/907 kg
Stack Height	Static/Dynamic	6/5	6/4
Tare Weight (may vary)		93 lb/42 kg	130 lb/59 kg
Collapsed Height		Fixed Wall	13.6"/345 mm
Return Ratio		1:1	1.8:1
Truckload Quantity (Collapsed)	48' with cover/no cover	N/A	196/224
	53' with cover/no cover	N/A	210/240
Truckload Quantity (Open)	48' with cover/no cover	156/168	84/112
	53' with cover/no cover	168/180	90/120
40' ISO Container (Collapsed)	Std. with cover/no cover	N/A	126/147
	Hi Cube with cover/no cover	N/A	147/168
40' ISO Container (Open)	Std. with cover/no cover	105/105	63/63
	Hi Cube with cover/no cover	105/126	63/84

The 10 designation indicates a container with a Closed Deck.  
Open Deck containers are designated with the 11 code.

ROPAK 4048 containers correspond to standard Grocery Manufacturers of America (GMA) pallet size.  
Please call Customer Service at 1.800.442.4892 for more information.



ROPAK 4048 containers with a "10" part number designation feature a Closed Deck, shown above.



ROPAK 4048 containers with an "11" part number designation feature an Open Deck, shown above.

**48" x 40" Footprint ROPAK Reusable Containers are Perfect for:**

Grocery Distribution | Hardware | Metal Parts | Plastics and Rubber Resins and Powders | Retail Distribution | Textiles | Tools

<b>1029/1129</b>	<b>1034/1134</b>	<b>1039/1139</b>	<b>1042/1142</b>	<b>10423<sup>1</sup>/11423<sup>1</sup></b>	<b>1047/1147</b>	<b>1050/1150</b>
47.3"/1201 mm	47.3"/1201 mm	47.3"/1201 mm	47.3"/1201 mm	47.3"/1201 mm	47.3"/1201 mm	47.3"/1201 mm
39.6"/1006 mm	39.6"/1006 mm	39.6"/1006 mm	39.6"/1006 mm	39.6"/1006 mm	39.6"/1006 mm	39.6"/1006 mm
29.9"/759 mm	34.3"/871 mm	39.4"/1001 mm	42.3"/1074 mm	42.3"/1074 mm	47.5"/1207 mm	50.1"/1273 mm
43.6"/1107 mm	43.6"/1107 mm	43.6"/1107 mm	43.6"/1107 mm	43.6"/1107 mm	43.6"/1107 mm	43.6"/1107 mm
36"/914 mm	36"/914 mm	36"/914 mm	36"/914 mm	36"/914 mm	36"/914 mm	36"/914 mm
24.1"/612 mm	28.6"/726 mm	33.8"/859 mm	36.6"/930 mm	36.6"/930 mm	41.9"/1064 mm	44.5"/1130 mm
23.1"/587 mm	27.6"/701 mm	32.8"/833 mm	35.6"/904 mm	35.6"/904 mm	40.9"/1039 mm	43.5"/1105 mm
0, 1, 2, 3, 4	0, 1, 2, 3, 4	0, 1, 2, 3, 4	0, 1, 2, 3, 4	0, 1, 2, 3, 4	0, 1, 2, 3, 4	0, 1, 2, 3, 4
32.7"/830 mm	32.7"/830 mm	32.7"/830 mm	32.7"/830 mm	32.7"/830 mm	32.7"/830 mm	32.7"/830 mm
12.5"/317 mm	16.7"/424 mm	19.4"/493 mm	20.7"/525 mm	19.4"/493 mm	19.4"/493 mm	20.7"/525 mm
32.6"/828 mm	32.7"/831 mm	32.7"/831 mm	32.7"/831 mm	32.7"/831 mm	32.7"/831 mm	32.7"/831 mm
12.6"/320 mm	16.7"/424 mm	19.4"/493 mm	20.7"/526 mm	19.4"/493 mm	19.4"/493 mm	20.7"/526 mm
21.1 ft <sup>3</sup> /0.59 m <sup>3</sup>	25.2 ft <sup>3</sup> /0.71 m <sup>3</sup>	29.8 ft <sup>3</sup> /0.83 m <sup>3</sup>	32.5 ft <sup>3</sup> /0.91 m <sup>3</sup>	32.4 ft <sup>3</sup> /0.91 m <sup>3</sup>	37.1 ft <sup>3</sup> /1.04 m <sup>3</sup>	39.5 ft <sup>3</sup> /1.11 m <sup>3</sup>
2000 lb/907 kg	2000 lb/907 kg	2000 lb/907 kg	1750 lb/794 kg	1750 lb/794 kg	1750 lb/794 kg	1750 lb/794 kg
6/3	6/3	5/2	5/2	5/2	4/2	4/2
142 lb/64 kg	159 lb/72 kg	169 lb/77 kg	180 lb/82 kg	182 lb/83 kg	191 lb/87 kg	203 lb/92 kg
13.6"/345 mm	13.6"/345 mm	13.6"/345 mm	13.6"/345 mm	16.13"/410 mm	21.4"/544 mm	21.4"/544 mm
2.1:1	2.5:1	2.9:1	3.1:1	2.6:1	2.2:1	2.3:1
196/224	196/224	196/224	196/224	168/168	112/140	112/140
210/240	210/240	210/240	210/240	180/180	120/150	120/150
84/84	56/84	56/56	56/56	56/56	56/56	56/56
90/90	60/90	60/60	60/60	60/60	60/60	60/60
126/147	126/147	126/147	126/147	105/105	84/84	84/84
147/168	147/168	147/168	147/168	126/126	84/105	84/105
42/63	42/42	42/42	42/42	42/42	21/21	21/21
63/84	42/63	42/42	42/42	42/42	42/42	42/42

<sup>1</sup> This model is specially designed with a 3" storage space to accommodate dunnage.

All dimensions and specifications are approximate. Interior height dimensions measured from center. Tare weight will vary based on color, height, drop door configuration and deck options. Performance characteristics are based on uniform static loads and may be affected by concentrated loads and elevated temperatures. Label holder availability and options depend on container height. HDPE materials and workmanship guaranteed for 3 years.

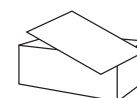

**Cover Available**

Please see page 24 of this catalog for the cover options offered for ROPAK 4048 containers.

# ROPAK™ 4548

## most popular heavy-duty container



8

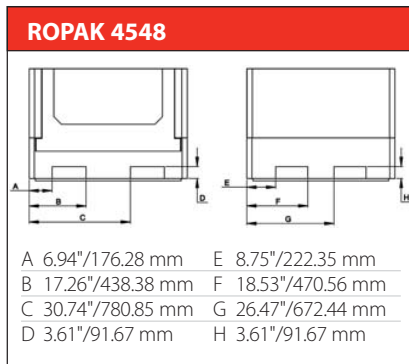

### ROPAK 4548 CONTAINER SPECIFICATIONS

		4A25	4A338'
Part Number			
Exterior Dimensions	length	48"/1219 mm	48"/1219 mm
	width	45"/1143 mm	45"/1143 mm
	height	25"/635 mm	33"/838 mm
Interior Dimensions	length	44"/1118 mm	44"/1118 mm
	width	41.5"/1054 mm	41.5"/1054 mm
	height	19.4"/493 mm	27.5"/699 mm
	height to fill line	18.6"/472 mm	26.6"/676 mm
Drop Door Options		0, 1, 2	0, 1, 2
48" Side Drop Door Dimensions	width	33"/838 mm	33"/838 mm
	height	12.4"/315 mm	12.4"/315 mm
45" Side Wing-Style Drop Door	width top	N/A	N/A
	width bottom	N/A	N/A
	height	N/A	N/A
Container Volume		19.7 ft <sup>3</sup> /0.55 m <sup>3</sup>	28.3 ft <sup>3</sup> /0.79 m <sup>3</sup>
Container Capacity	48" side drop doors only	2000 lb/907 kg	2000 lb/907 kg
	45" adjacent drop doors	N/A	N/A
Stack Height		Static/Dynamic	6/4
Tare Weight (may vary)		119 lb/54 kg	143 lb/65 kg
Collapsed Height		13.1"/333 mm	21.1"/536 mm
Return Ratio		1.9:1	1.6:1
Truckload Quantity (Collapsed)	48' with cover/no cover	168/192	96/120
	53' high cube cover/no cover	182/208	104/130
Truckload Quantity (Open)	48' with cover/no cover	72/96	48/72
	53' high cube cover/no cover	78/104	52/78
40' ISO Container (Collapsed)	Std. with cover/no cover	108/126	64/72
	Hi Cube with cover/no cover	120/144	80/90
40' ISO Container (Open)	Std. with cover/no cover	51/54	34/36
	Hi Cube with cover/no cover	64/72	51/54

This container features an Open Deck.

Please call Customer Service at 1.800.442.4892 for more information.

**48" x 45" Footprint ROPAK Reusable Containers are Perfect for:**

Appliance Components | Automotive Components | Chemicals | Computers and Peripherals | Industrial Equipment Components  
Industrial Supplies | Paper Products | Plastics and Rubber | Subassemblies | Textiles

4A34	4A39	4A42	4A48	4A50
48"/1219 mm	48"/1219 mm	48"/1219 mm	48"/1219 mm	48"/1219 mm
45"/1143 mm	45"/1143 mm	45"/1143 mm	45"/1143 mm	45"/1143 mm
34"/864 mm	39"/991 mm	42"/1067 mm	48"/1219 mm	50"/1270 mm
44"/1118 mm	44"/1118 mm	44"/1118 mm	44"/1118 mm	44"/1118 mm
41.5"/1054 mm	41.5"/1054 mm	41.5"/1054 mm	41.5"/1054 mm	41.5"/1054 mm
28.4"/721 mm	33.3"/846 mm	36.6"/930 mm	42.5"/1080 mm	44.5"/1130 mm
27.5"/699 mm	32.3"/820 mm	35.4"/899 mm	41.5"/1054 mm	43.3"/1100 mm
0, 1, 2, 3, 4	0, 1, 2	0, 1, 2, 3, 4	0, 1, 2, 3, 4	0, 1, 2, 3, 4
33"/838 mm	33"/838 mm	33"/838 mm	33"/838 mm	33"/838 mm
16.8"/426 mm	12.4"/315 mm	21.8"/553 mm	21.8"/553 mm	21.8"/553 mm
25.8"/655 mm	N/A	25.8"/655 mm	25.8"/655 mm	25.8"/655 mm
15.2"/386 mm	N/A	15.2"/386 mm	15.2"/386 mm	15.2"/386 mm
15.2"/386 mm	N/A	15.2"/386 mm	15.2"/386 mm	15.2"/386 mm
29.2 ft <sup>3</sup> /0.82 m <sup>3</sup>	34.8 ft <sup>3</sup> /0.97 m <sup>3</sup>	38 ft <sup>3</sup> /1.06 m <sup>3</sup>	44.4 ft <sup>3</sup> /1.24 m <sup>3</sup>	46.5 ft <sup>3</sup> /1.30 m <sup>3</sup>
2000 lb/907 kg	1700 lb/771 kg	1700 lb/771 kg	1500 lb/680.4 kg	1500 lb/680.4 kg
1500 lb/680.4 kg	N/A	1200 lb/544 kg	1200 lb/544 kg	1200 lb/544 kg
6/3	4/2	4/2	4/2	4/2
145 lb/66 kg	166 lb/75 kg	175 lb/79.4 kg	188 lb/85.2 kg	199 lb/90 kg
13.1"/333 mm	27.1"/688 mm	21.1"/536 mm	27.1"/688 mm	29.1"/739 mm
2.6:1	1.4:1	2:1	1.8:1	1.7:1
168/192	72/96	96/120	72/96	72/72
182/208	78/104	104/130	78/104	78/78
48/72	48/48	48/48	48/48	24/48
52/78	52/52	52/52	52/52	26/52
108/126	51/54	64/72	51/54	51/54
120/144	51/54	80/90	51/54	51/54
34/36	34/36	34/36	17/18	17/18
51/54	34/36	34/36	34/36	34/36



9

The ROPAK 4548 is also offered with an optional Wing-Style Drop Door, available on the 45" side.

<sup>1</sup> This model is specially designed with an 8" storage space to accommodate dunnage.

All dimensions and specifications are approximate. Interior height dimensions measured from center. Tare weight will vary based on color, height and drop door configuration. Performance characteristics are based on uniform static loads and may be affected by concentrated loads and elevated temperatures. Label holder availability and options depend on container height. HDPE materials and workmanship guaranteed for 3 years.



**Cover Available**

Please see page 24 of this catalog for the cover options offered for ROPAK 4548 containers.

**ROPAK Industry Standard Reusable Containers are Perfect for:**

Aluminum Components | Blow Molded Bottles | PET Preforms | Plastic Molded Components  
Snack Food Applications | Textiles | Vacuum Formed Food Trays

# ROPAK™ Industry Standard

## offered in two, most-popular sizes



10

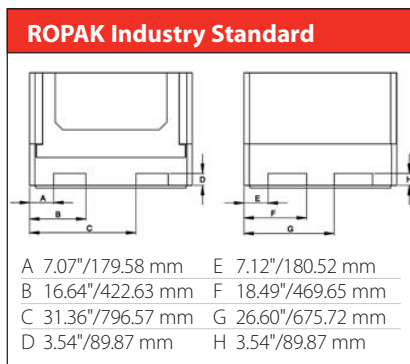

**ROPAK INDUSTRY STANDARD CONTAINER SPECIFICATIONS**

Part Number		<b>4825</b>	<b>4834</b>
Exterior Dimensions	length	48"/1219 mm	48"/1219 mm
	width	45"/1143 mm	45"/1143 mm
	height	25"/635 mm	34"/864 mm
Interior Dimensions	length	44.3"/1124 mm	44.3"/1124 mm
	width	41.5"/1054 mm	41.5"/1054 mm
	height	19.4"/493 mm	28.4"/721 mm
	height to fill line	18.6"/472 mm	27.5"/699 mm
Drop Door Options		0, 1, 2	0, 1, 2
48" Drop Door Dimensions	width	33"/838 mm	33"/838 mm
	height	12.4"/315 mm	16.8"/426 mm
Container Volume		19.7 ft <sup>3</sup> /0.55 m <sup>3</sup>	29.2 ft <sup>3</sup> /0.82 m <sup>3</sup>
Container Capacity		1500 lb/680.4 kg	1500 lb/680.4 kg
Stack Height	Static/Dynamic	6/4	6/3
Tare Weight (may vary)		114 lb/52 kg	140 lb/64 kg
Collapsed Height		13.1"/333 mm	13.1"/333 mm
Return Ratio		1.9:1	2.6:1
Truckload Quantity (Collapsed)	48' with cover/no cover	168/192	168/192
	53' with cover/no cover	182/208	182/208
Truckload Quantity (Open)	48' with cover/no cover	72/96	48/72
	53' with cover/no cover	78/104	52/78
40' ISO Container (Collapsed)	Std. with cover/no cover	108/126	108/126
	Hi Cube with cover/no cover	120/144	120/144
40' ISO Container (Open)	Std. with cover/no cover	51/54	34/36
	Hi Cube with cover/no cover	64/72	51/54

This container features a Closed Deck.

Please call Customer Service at 1.800.442.4892 for more information.



**Cover Available**

Please see page 24 of this catalog for the cover options offered for ROPAK Industry Standard containers.

All dimensions and specifications are approximate. Interior height dimensions measured from center. Tare weight will vary based on color, height and drop door configuration. Performance characteristics are based on uniform static loads and may be affected by concentrated loads and elevated temperatures. Label holder availability and options depend on container height. HDPE materials and workmanship guaranteed for 3 years.

**48" x 45" Footprint ROPAK Hopper Bottom Reusable Containers are Perfect for:**

Adhesives | Agricultural Products | Bulk Solids | Crowns and Closures  
 Dry Chemicals | Plastic Resins | Powders | Preforms | Seed, Grain and Feed

# ROPAK™ Hopper Bottom dispenses small parts, powders

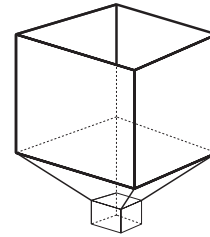
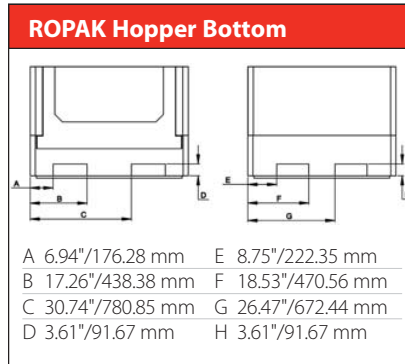

Liners are available for the ROPAK Hopper Bottom container.

Please call Customer Service at 1.800.442.4892 for more information.

11

**ROPAK HOPPER BOTTOM CONTAINER SPECIFICATIONS**

Part Number		<b>4539HB</b>	<b>4548HB</b>	<b>4550HB</b>
Exterior Dimensions	length	48"/1219 mm	48"/1219 mm	48"/1219 mm
	width	45"/1143 mm	45"/1143 mm	45"/1143 mm
	height	39"/991 mm	48"/1219 mm	50"/1270 mm
Interior Dimensions	length	44"/1118 mm	44"/1118 mm	44"/1118 mm
	width	41.5"/1054 mm	41.5"/1054 mm	41.5"/1054 mm
	height	33.6"/853 mm	42.5"/1080 mm	44.5"/1130 mm
	height to fill line	32.7"/831 mm	41.8"/1062 mm	43.8"/1113 mm
Drop Door Options		N/A	N/A	N/A
Container Volume		25.3 ft <sup>3</sup> /0.71 m <sup>3</sup>	34.8 ft <sup>3</sup> /0.97 m <sup>3</sup>	37 ft <sup>3</sup> /1.04 m <sup>3</sup>
Container Capacity		2000 lb/907 kg	2000 lb/907 kg	2000 lb/907 kg
Stack Height	Static/Dynamic	4/2	4/2	4/2
Tare Weight (may vary)		207 lb/94 kg	233 lb/106 kg	237 lb/108 kg
Collapsed Height		27.1"/688 mm	27.1"/688 mm	29.1"/739 mm
Return Ratio		1.4:1	1.8:1	1.7:1
Truckload Quantity (Collapsed)	48' with cover/no cover	72/72	72/72	72/72
	53' with cover/no cover	78/78	78/78	78/78
Truckload Quantity (Open)	48' with cover/no cover	48/48	48/48	24/48
	53' with cover/no cover	52/52	52/52	26/52
40' ISO Container (Collapsed)	Std. with cover/no cover	51/54	51/54	51/54
	Hi Cube with cover/no cover	51/54	51/54	51/54
40' ISO Container (Open)	Std. with cover/no cover	34/36	17/18	17/18
	Hi Cube with cover/no cover	34/36	34/36	34/36
Standard Color		Beige	Beige	Beige

Interior funnel opening is 6.25" x 11".  
 Flow restrictors are available.

Please call Customer Service at 1.800.442.4892 for more information.

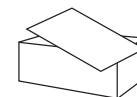

**Cover Available**

Please see page 24 of this catalog for the cover options offered for ROPAK Hopper Bottom containers.

All dimensions and specifications are approximate. Interior height dimensions measured from center. Tare weight will vary based on color and height. Performance characteristics are based on uniform static loads and may be affected by concentrated loads and elevated temperatures. Label holder availability and options depend on container height. HDPE materials and workmanship guaranteed for 3 years.

**48" x 44" Footprint MAX<sup>3</sup> Reusable Containers are Perfect for:**  
 Blown Bottles | Cosmetic Packaging | Crowns | Metal Closures | PET Preforms  
 Pharmaceutical Packaging | Plastic Closure Moldings | Synthetic Cork

# MAX<sup>3</sup>™ 4448

## maxed payloads lower shipping costs

12



### MAX<sup>3</sup> CONTAINER SPECIFICATIONS

Part Number		<b>4450</b>
Exterior Dimensions	length	48"/1219 mm
	width	44.25"/1124 mm
	height	50.1"/1273 mm
Interior Dimensions	length	45.5"/1156 mm
	width	41.75"/1060 mm
	height	44.75"/1137 mm
	height to fill line	43.75"/1111 mm
Collapsed Height	with no cover	11"/279.4 mm
Stack Height	Static/Dynamic	5/2
Container Volume		52 ft <sup>3</sup> /1.472 m <sup>3</sup>
Container Capacity (Dynamic)		1000 lb/453.6 kg
Container Tare Weight		85 lb/38.6 kg
Cover Tare Weight		9.8 lb/4.4 kg
Return Ratio		4.5:1
Truckload Quantity (Collapsed)	48' with cover	234
	53' high cube with cover	252
Truckload Quantity (Open)	48' with cover	52
	53' high cube with cover	56
40' ISO Container (Collapsed)	Std. with cover	168
	Hi Cube with cover	189
40' ISO Container (Open)	Std. with cover	42
	Hi Cube with cover	42
Pallet Fork Entry		4-way
Standard Color		Natural

Covers are included with all MAX<sup>3</sup> containers.  
 Please call Customer Service at 1.800.442.4892 for more information.

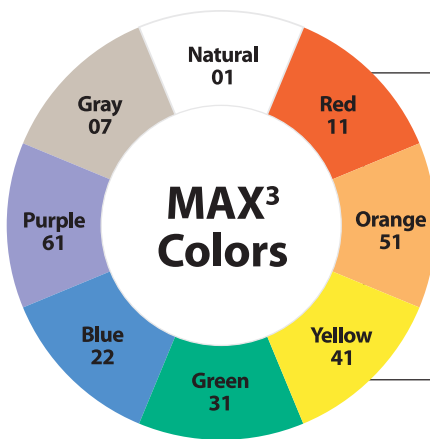

### Specify Colors to Customize Your MAX<sup>3</sup> Container System

MAX<sup>3</sup> containers are available in a variety of colors, listed at left—minimum quantities may be required for some colors. Containers may be specified with different colored sidewalls and bases.

Please note, these color swatches are only a representation of injection-molded resins. Actual MAX<sup>3</sup> product color may vary slightly due to both the resin materials and this catalog's printing process. Due to both design and resin, MAX<sup>3</sup> containers appear slightly transparent, helping you to determine the volume of contents.

All dimensions and specifications are approximate. Interior height dimensions measured from center. Performance characteristics are based on uniform static loads and may be affected by concentrated loads and elevated temperatures. Materials and workmanship guaranteed for 3 years. Material: High Impact Polypropylene.

**48" x 45" Footprint Fixed Wall ROPAK Reusable Containers are Perfect for:**

Appliance Components | Automotive Components | Industrial Equipment Components  
Industrial Supplies | Metal Parts | Stampings | Subassemblies

# ROPAK™ Fixed Wall

## rigid sides offer greater strength

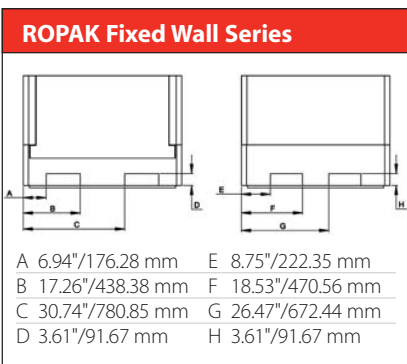

### ROPAK FIXED WALL CONTAINER SPECIFICATIONS

Part Number		<b>4512</b>	<b>4515</b>
Exterior Dimensions	length	48"/1219 mm	48"/1219 mm
	width	45"/1143 mm	45"/1143 mm
	height	12.1"/307 mm	15"/381 mm
Interior Dimensions	length	44.3"/1125 mm	44.3"/1125 mm
	width	41.5"/1054 mm	41.5"/1054 mm
	height	6.4"/163 mm	9.3"/236 mm
	height to fill line	5.4"/137 mm	8.3"/210 mm
Container Volume		5.6 ft <sup>3</sup> /0.16 m <sup>3</sup>	8.8 ft <sup>3</sup> /0.25 m <sup>3</sup>
Container Capacity		2000 lb/907 kg	2000 lb/907 kg
Stack Height	Static/Dynamic	6/6	6/6
Tare Weight (may vary)		82 lb/37 kg	92 lb/42 kg
Return Ratio		1:1	1:1
Truckload Quantity	48' with cover/no cover	168/216	144/168
	53' with cover/no cover	182/234	156/182
40' ISO Container	Std. with cover/no cover	126/144	90/108
	Hi Cube with cover/no cover	126/162	108/126

13

### ROPAK FIXED WALL CONTAINER SPECIFICATIONS

Part Number		<b>4517</b>	<b>4519</b>	<b>4521</b>	<b>4524</b>
Exterior Dimensions	length	48"/1219 mm	48"/1219 mm	48"/1219 mm	48"/1219 mm
	width	45"/1143 mm	45"/1143 mm	45"/1143 mm	45"/1143 mm
	height	16.9"/429 mm	19.3"/490 mm	21.3"/541 mm	24.8"/630 mm
Interior Dimensions	length	44.3"/1125 mm	44.3"/1125 mm	44.3"/1125 mm	44.3"/1125 mm
	width	41.5"/1054 mm	41.5"/1054 mm	41.5"/1054 mm	41.5"/1054 mm
	height	11.3"/287 mm	13.7"/348 mm	15.7"/399 mm	19"/483 mm
	height to fill line	10.3"/262 mm	12.7"/323 mm	14.7"/373 mm	18"/457 mm
Container Volume		10.9 ft <sup>3</sup> /0.31 m <sup>3</sup>	13.2 ft <sup>3</sup> /0.37 m <sup>3</sup>	15.4 ft <sup>3</sup> /0.43 m <sup>3</sup>	19.2 ft <sup>3</sup> /0.54 m <sup>3</sup>
Container Capacity		2000 lb/907 kg	2000 lb/907 kg	2000 lb/907 kg	2000 lb/907 kg
Stack Height	Static/Dynamic	6/6	6/6	6/6	6/4
Tare Weight (may vary)		98 lb/45 kg	102 lb/46 kg	108 lb/49 kg	120 lb/54 kg
Return Ratio		1:1	1:1	1:1	1:1
Truckload Quantity	48' with cover/no cover	120/144	120/120	96/120	96/96
	53' with cover/no cover	130/156	130/130	104/130	104/104
40' ISO Container	Std. with cover/no cover	90/90	72/90	72/72	54/54
	Hi Cube with cover/no cover	90/108	90/90	72/90	72/72

Several other ROPAK containers with different footprint dimensions also feature fixed sidewalls. These include **3A18** (32" x 30" footprint—page 4), **1016/1116** (40" x 48" footprint—page 6), **5619** (56" x 48" footprint—page 14), **6519** (64.5" x 48" footprint—page 16), and **7019** (70" x 48" footprint—page 18).

Please call Customer Service at 1.800.442.4892 for more information.

All dimensions and specifications are approximate. Interior height dimensions measured from center. Tare weight will vary based on color, height and drop door configuration. Performance characteristics are based on uniform static loads and may be affected by concentrated loads and elevated temperatures. Label holder availability and options depend on container height. HDPE materials and workmanship guaranteed for 3 years.

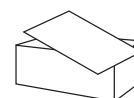

**Cover Available**

Please see page 24 of this catalog for the cover options offered for ROPAK Fixed Wall containers.

# ROPAK™ 5648

## extended length for long parts



14

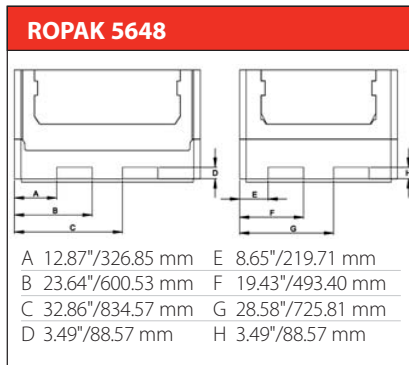

### ROPAK 5648 CONTAINER SPECIFICATIONS

		5619	5625
Part Number		5619	5625
Exterior Dimensions	length	56.5"/1435 mm	56.5"/1435 mm
	width	48"/1219 mm	48"/1219 mm
	height	19"/483 mm	25"/635 mm
Interior Dimensions	length	53.3"/1354 mm	53.3"/1354 mm
	width	44.8"/1137 mm	44.8"/1137 mm
	height	12.8"/325 mm	18.7"/475 mm
	height to fill line	11.8"/300 mm	17.7"/450 mm
Drop Door Options		N/A	0, 1, 2, 3, 4
56.5" Side Drop Door Dimensions	width	N/A	44.3"/1125 mm
	height	N/A	12.2"/310 mm
48" Side Drop Door Dimensions	width	N/A	34.9"/886 mm
	height	N/A	9"/229 mm
Container Volume		16.3 ft <sup>3</sup> /0.46 m <sup>3</sup>	24.5 ft <sup>3</sup> /0.69 m <sup>3</sup>
Container Capacity		2000 lb/907 kg	2000 lb/907 kg
Stack Height		Static/Dynamic	6/4
Tare Weight (may vary)		128 lb/58 kg	166 lb/75 kg
Collapsed Height		Fixed Wall	13"/330 mm
Return Ratio		1:1	2:1
Truckload Quantity (Collapsed)	48'	N/A	160
	53'	N/A	176
Truckload Quantity (Open)	48'	100	66
	53'	110	88
40' ISO Container (Collapsed)	Std.	N/A	63
	Hi Cube	N/A	72
40' ISO Container (Open)	Std.	36	27
	Hi Cube	45	45

This container features a Closed Deck.

Please call Customer Service at 1.800.442.4892 for more information.

**56" x 48" Footprint ROPAK Extended Length Reusable Containers are Perfect for:**

Appliance Components | Automotive Components | Furniture Components  
 HVAC Components | Metal Stampings | Textiles

<b>5634</b>	<b>5642</b>
56.5"/1435 mm	56.5"/1435 mm
48"/1219 mm	48"/1219 mm
34"/864 mm	42"/1067 mm
53.3"/1354 mm	53.3"/1354 mm
44.8"/1137 mm	44.8"/1137 mm
27.7"/704 mm	35.7"/907 mm
26.7"/678 mm	34.7"/881 mm
0, 1, 2, 3, 4	0, 1, 2, 3, 4
44.3"/1125 mm	44.3"/1125 mm
16.4"/417 mm	20.2"/513 mm
34.9"/886 mm	34.9"/886 mm
16.4"/417 mm	16.4"/417 mm
36.9 ft <sup>3</sup> /1.04 m <sup>3</sup>	47.9 ft <sup>3</sup> /1.36 m <sup>3</sup>
2000 lb/907 kg	2000 lb/907 kg
6/3	4/2
201 lb/91 kg	220 lb/100 kg
13"/330 mm	22"/559 mm
2.6:1	2:1
160	90
176	100
44	44
66	44
63	36
72	36
18	18
27	18



The ROPAK 5648 offers a Drop Door on the 56" side of the container to provide easier access to contents.

All dimensions and specifications are approximate. Interior height dimensions measured from center. Tare weight will vary based on color, height and drop door configuration. Performance characteristics are based on uniform static loads and may be affected by concentrated loads and elevated temperatures. Label holder availability and options depend on container height. HDPE materials and workmanship guaranteed for 3 years.



**Cover Available**

Please see page 24 of this catalog for the cover options offered for ROPAK 5648 Extended Length containers.

# ROPAK™ 6448

## extended length for longer parts



16

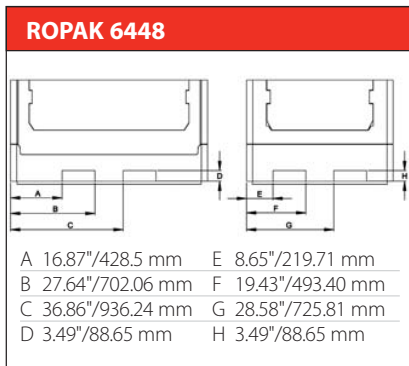

### ROPAK 6448 CONTAINER SPECIFICATIONS

Part Number		6519	6525
Exterior Dimensions	length	64.5"/1638 mm	64.5"/1638 mm
	width	48"/1219 mm	48"/1219 mm
	height	19"/483 mm	25"/635 mm
Interior Dimensions	length	61.3"/1557 mm	61.3"/1557 mm
	width	44.8"/1138 mm	44.8"/1138 mm
	height	12.8"/325 mm	18.8"/477 mm
	height to fill line	11.8"/300 mm	17.8"/452 mm
Drop Door Options		N/A	0, 1, 2, 3, 4
65" Side Drop Door Dimensions	width	N/A	50.3"/1277 mm
	height	N/A	12.8"/325 mm
48" Side Drop Door Dimensions	width	N/A	32.4"/823 mm
	height	N/A	9.6"/244 mm
Container Volume		18.8 ft <sup>3</sup> /0.53 m <sup>3</sup>	28.3 ft <sup>3</sup> /0.80 m <sup>3</sup>
Container Capacity		2000 lb/907 kg	2000 lb/907 kg
Stack Height	Static/Dynamic	5/4	5/4
Tare Weight (may vary)		160 lb/73 kg	186 lb/84 kg
Collapsed Height	Fixed Wall		12.9"/328 mm
Return Ratio		1:1	1.9:1
Truckload Quantity (Collapsed)	48'	80	128
	53'	90	144
Truckload Quantity (Open)	48'	80	64
	53'	90	72
40' ISO Container (Collapsed)	Std.	36	63
	Hi Cube	45	72
40' ISO Container (Open)	Std.	36	27
	Hi Cube	45	36

This container features a Closed Deck.

Please call Customer Service at 1.800.442.4892 for more information.

**64.5" x 48" Footprint ROPAK Extended Length Reusable Containers are Perfect for:**

Appliance Components | Automotive Components | Body Side Moldings | Carpet | Drive Shafts | Exterior Trim  
 Furniture Components | Headlights | HVAC Components | Interior Trim | Metal Stampings | Textiles

6534	6542	6550
64.5"/1638 mm	64.5"/1638 mm	64.5"/1638 mm
48"/1219 mm	48"/1219 mm	48"/1219 mm
34"/864 mm	42"/1067 mm	50"/1270 mm
61.3"/1557 mm	61.3"/1557 mm	61.3"/1557 mm
44.8"/1138 mm	44.8"/1138 mm	44.8"/1138 mm
27.8"/706 mm	35.8"/909 mm	43.8"/1112 mm
26.8"/681 mm	34.8"/884 mm	42.8"/1087 mm
0, 1, 2, 3, 4	0, 1, 2, 3, 4	0, 1, 2, 3, 4
50.3"/1277 mm	50.3"/1277 mm	50.3"/1277 mm
17"/432 mm	20.8"/528 mm	24.9"/632 mm
32.4"/823 mm	32.4"/823 mm	32.4"/823 mm
17"/432 mm	16"/406 mm	16"/406 mm
42.6 ft <sup>3</sup> /1.21 m <sup>3</sup>	55.3 ft <sup>3</sup> /1.57 m <sup>3</sup>	68.0 ft <sup>3</sup> /1.93 m <sup>3</sup>
2000 lb/907 kg	2000 lb/907 kg	2000 lb/907 kg
5/2	4/2	4/2
209 lb/95 kg	232 lb/105 kg	252 lb/114 kg
12.9"/328 mm	22.1"/561 mm	22.1"/561 mm
2.6:1	1.9:1	2.3:1
128	80	80
144	90	90
48	32	32
54	36	36
63	36	36
72	36	36
18	18	18
27	18	18



17

To provide easier access to contents, the ROPAK 6448 offers a Drop Door on the 64.5" side of the container.

All dimensions and specifications are approximate. Interior height dimensions measured from center. Tare weight will vary based on color, height and drop door configuration. Performance characteristics are based on uniform static loads and may be affected by concentrated loads and elevated temperatures. Label holder availability and options depend on container height. HDPE materials and workmanship guaranteed for 3 years.

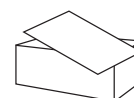

**Cover Available**

Please see page 24 of this catalog for the cover options offered for ROPAK 6448 Extended Length containers.

# ROPAK™ 7048

extended length for even longer parts



18

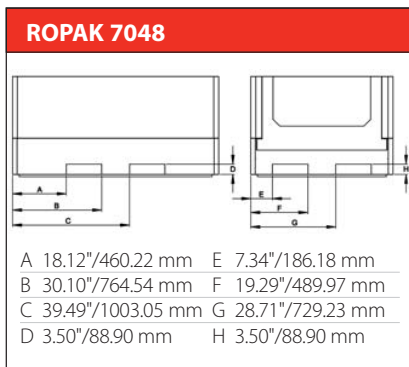

## ROPAK 7048 CONTAINER SPECIFICATIONS

Part Number		7019	7025
Exterior Dimensions	length	70"/1778 mm	70"/1778 mm
	width	48"/1219 mm	48"/1219 mm
	height	19"/483 mm	25"/635 mm
Interior Dimensions	length	66.4"/1687 mm	66.4"/1687 mm
	width	44.5"/1130 mm	44.5"/1130 mm
	height	13.1"/333 mm	18.8"/478 mm
	height to fill line	12.1"/307 mm	17.9"/455 mm
Drop Door Options		N/A	0, 1, 2
70" Side Drop Door Dimensions	width	N/A	N/A
	height	N/A	N/A
48" Side Drop Door Dimensions	width	N/A	33"/838 mm
	height	N/A	12.4"/315 mm
Container Volume		20.7 ft <sup>3</sup> /0.58 m <sup>3</sup>	30.6 ft <sup>3</sup> /0.86 m <sup>3</sup>
Container Capacity	Rigid	2000 lb/907 kg	2000 lb/907 kg
	Distributed	1500 lb/680.4 kg	1500 lb/680.4 kg
	Wing Wall	N/A	N/A
Stack Height	Static/Dynamic	4/4	4/4
Tare Weight (may vary)		142 lb/64 kg	173 lb/78 kg
Collapsed Height	Fixed Wall		13.3"/338 mm
Return Ratio		1:1	1.9:1
Truckload Quantity (Collapsed)	48'	80	128
	53'	85	136
Truckload Quantity (Open)	48'	80	64
	53'	85	68
40' ISO Container (Collapsed)	Std.	36	63
	Hi Cube	45	72
40' ISO Container (Open)	Std.	36	27
	Hi Cube	45	36

This container features a Closed Deck.

Please call Customer Service at 1.800.442.4892 for more information.

**70" x 48" Footprint ROPAK Extended Length Reusable Containers are Perfect for:**

Appliance Components | Automotive Components | Furniture Components  
 HVAC Components | Metal Stampings | Textiles

<b>7034</b>	<b>7041</b>	<b>7050</b>
70"/1778 mm	70"/1778 mm	70"/1778 mm
48"/1219 mm	48"/1219 mm	48"/1219 mm
34"/864 mm	41"/1041 mm	50"/1270 mm
66.4"/1687 mm	66.4"/1687 mm	66.4"/1687 mm
44.5"/1130 mm	44.5"/1130 mm	44.5"/1130 mm
27.9"/709 mm	34.9"/886 mm	44"/1118 mm
26.9"/683 mm	34"/864 mm	43"/1092 mm
0, 1, 2, 3, 4	0, 1, 2, 3, 4	0, 1, 2, 3, 4
45.7"/1160 mm	N/A	45.7"/1160 mm
16.7"/424 mm	N/A	16.7"/424 mm
33"/838 mm	33"/838 mm	33"/838 mm
16.8"/426 mm	12.4"/315 mm	21.8"/553 mm
46 ft <sup>3</sup> /1.29 m <sup>3</sup>	58.1 ft <sup>3</sup> /1.63 m <sup>3</sup>	73.5 ft <sup>3</sup> /2.058 m <sup>3</sup>
2000 lb/907 kg	2000 lb/907 kg	2000 lb/907 kg
1500 lb/680.4 kg	1500 lb/680.4 kg	1500 lb/680.4 kg
1000 lb/454 kg	N/A	1000 lb/454 kg
4/3	4/2	4/2
228 lb/103 kg	267 lb/121 kg	303 lb/137 kg
13.3"/338 mm	29.2"/742 mm	29.2"/742 mm
2.6:1	1.4:1	1.7:1
128	48	48
136	51	51
48	32	32
51	34	34
63	27	27
72	27	27
18	18	9
27	18	18



The ROPAK 7048's Drop Doors on the 70" side are attached with articulated hinges. These innovative hinges allow the door to lay flat against the side of the container, reducing the potential for damage and increasing handling safety.

Rigid Load: Part is rigid across length and spans a minimum of 60".  
 Distributed Load: All other unsupported loads.

All dimensions and specifications are approximate. Interior height dimensions measured from center. Tare weight will vary based on color, height and drop door configuration. Performance characteristics are based on uniform static loads and may be affected by concentrated loads and elevated temperatures. Label holder availability and options depend on container height. HDPE materials and workmanship guaranteed for 3 years.

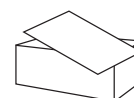

**Cover Available**

Please see page 24 of this catalog for the cover options offered for ROPAK 7048 Extended Length containers.

78" x 48" Footprint ROPAK Extended Length Reusable Containers are Perfect for:

Appliance Components | Automotive Components | Furniture Components  
HVAC Components | Metal Stampings | Textiles

# ROPAK™ 7848

## extended length for longest parts

20

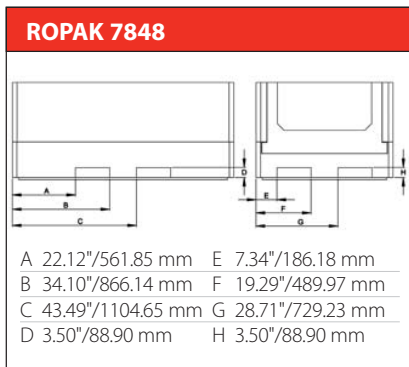

### ROPAK 7848 CONTAINER SPECIFICATIONS

Part Number		7825	7834
Exterior Dimensions	length	78"/1981 mm	78"/1981 mm
	width	48"/1219 mm	48"/1219 mm
	height	25"/635 mm	34"/864 mm
Interior Dimensions	length	74.5"/1892 mm	74.5"/1892 mm
	width	44.8"/1138 mm	44.8"/1138 mm
	height	19.1"/485 mm	28.1"/714 mm
	height to fill line	18.1"/460 mm	27.1"/688 mm
Drop Door Options		0, 1, 2	0, 1, 2, 3, 4
78" Side Drop Door Dimensions	width	N/A	45.7"/1160 mm
	height	N/A	16.8"/426 mm
48" Side Drop Door Dimensions	width	33"/383 mm	33"/383 mm
	height	12.4"/315 mm	16.8"/426 mm
Container Volume		34.9 ft <sup>3</sup> /0.99 m <sup>3</sup>	52.3 ft <sup>3</sup> /1.48 m <sup>3</sup>
Container Capacity	Rigid	2000 lb/907 kg	2000 lb/907 kg
	Distributed	1500 lb/680 kg	1500 lb/680 kg
Stack Height	Static/Dynamic	4/4	4/3
Tare Weight (may vary)		161 lb/73 kg	230 lb/104 kg
Collapsed Height		13.3"/333 mm	13.3"/333 mm
Return Ratio		1.9:1	2.6:1
Truckload Quantity (Collapsed)	48'	112	112
	53'	128	128
Truckload Quantity (Open)	48'	56	42
	53'	64	48
40' ISO Container (Collapsed)	Std.	63	63
	Hi Cube	72	72
40' ISO Container (Open)	Std.	27	18
	Hi Cube	36	27

This container features a Closed Deck.  
Please call Customer Service at 1.800.442.4892 for more information.

Rigid Load: Part is rigid across length and spans a minimum of 68".  
Distributed Load: All other unsupported loads.

All dimensions and specifications are approximate. Interior height dimensions measured from center. Tare weight will vary based on color, height and drop door configuration. Performance characteristics are based on uniform static loads and may be affected by concentrated loads and elevated temperatures. Label holder availability and options depend on container height. HDPE materials and workmanship guaranteed for 3 years.

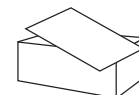

**Cover Available**

Please see page 24 of this catalog for the cover options offered for ROPAK 7848 Extended Length containers.

# ROPAK™ Pallets

## an eco-friendly alternative to wood



**ROPAK 3230 Pallet**

**4-Way Fork Entry**

A 2.13"/54.10 mm	E 5.88"/149.23 mm
B 12.36"/313.99 mm	F 13.00"/330.20 mm
C 19.89"/505.16 mm	G 17.25"/438.15 mm
D 3.44"/87.33 mm	H 2.25"/57.15 mm



**ROPAK 4048 Pallet**

A 7.62"/193.50 mm	E 5.49"/139.47 mm
B 20.65"/524.43 mm	F 16.91"/429.56 mm
C 26.96"/675.56 mm	G 22.56"/573.00 mm
D 3.47"/88.11 mm	H 3.47"/88.11 mm



**ROPAK 4548 Pallet**

A 6.94"/176.28 mm	E 8.75"/222.35 mm
B 17.26"/438.38 mm	F 18.53"/470.56 mm
C 30.74"/780.85 mm	G 26.47"/672.44 mm
D 3.61"/91.67 mm	H 3.61"/91.67 mm

### Pallets Available in a Variety of Sizes

Other pallet sizes can be fabricated. Please call Customer Service at 1.800.442.4892 for details.

#### ROPAK 3230 PALLET SPECIFICATIONS

Part Number		<b>3230P0</b> flat surface	<b>3230P0C<sup>1</sup></b> flat surface
		4-way entry	2-way entry/conveyable
Exterior Dimensions	length	32"/813 mm	32"/813 mm
	width	30"/762 mm	30"/762 mm
	height	5.6"/142 mm	5.6"/142 mm
	height with lip	N/A	N/A
Interior Dimensions	length	N/A	N/A
	width	N/A	N/A
Load Capacity	Static	30,000 lb	30,000 lb
Tare Weight (may vary)		22 lb/10.0 kg	23 lb/10.4 kg
Truckload Quantity	48'/53'	864/960	864/960
40' ISO Container	Standard/Hi Cube	588/672	588/672

21

**3230 Pallet** options include a 1" lip or a flat surface, Closed Deck or Open Deck.

#### ROPAK 4048 PALLET SPECIFICATIONS

Part Number		<b>4048P0</b> flat surface	<b>4048P1</b> with 1" lip
		4-way entry	4-way entry
Exterior Dimensions	length	47.3"/1201 mm	47.3"/1201 mm
	width	39.4"/1001 mm	39.4"/1001 mm
	height	5.7"/145 mm	N/A
	height with lip	N/A	6.7"/170 mm
Interior Dimensions	length	N/A	43.6"/1107 mm
	width	N/A	36"/914 mm
Load Capacity	Static	30,000 lb	30,000 lb
Tare Weight (may vary)		48 lb/21.8 kg	52 lb/23.6 kg
Truckload Quantity	48'/53'	448/480	448/480
40' ISO Container	Standard/Hi Cube	294/336	294/336

**4048 Pallet** options include a Closed Deck or Open Deck.

#### ROPAK 4548 PALLET SPECIFICATIONS

Part Number		<b>4548P0</b> flat surface	<b>4548P1</b> with 1" lip
		4-way entry	4-way entry
Exterior Dimensions	length	48"/1219 mm	48"/1219 mm
	width	45"/1143 mm	45"/1143 mm
	height	5.7"/145 mm	N/A
	height with lip	N/A	6.7"/170 mm
Interior Dimensions	length	N/A	44.2"/1123 mm
	width	N/A	41.5"/1054 mm
Load Capacity	Static	30,000 lb	30,000 lb
Tare Weight (may vary)		52 lb/23.6 kg	56 lb/25.4 kg
Truckload Quantity	48'/53'	384/416	384/416
40' ISO Container	Standard/Hi Cube	252/288	252/288

<sup>1</sup> This model has a 2-way conveyable base.

All dimensions and specifications are approximate. Tare weight will vary based on color and size. Performance characteristics are based on uniform static loads and may be affected by concentrated loads and elevated temperatures. HDPE materials and workmanship guaranteed for 3 years.

56" x 44" Footprint Reusable Bulk Pallets are Perfect for:

Beverage Cans | Composite Cans | Metal Cans  
PET Bottles | General Bulk Applications

# LINPAC's 4456 Bulk Pallet designed for lighter loads



22

## 4456 Bulk Pallet

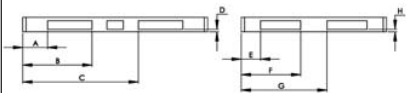

A	7.51"/190.86 mm	E	5.86"/148.77 mm
B	20.99"/533.04 mm	F	18.02"/457.81 mm
C	35.01"/889.36 mm	G	25.98"/659.79 mm
D	0.75"/19.05 mm	H	0.75"/19.05 mm

### 4456 BULK PALLET SPECIFICATIONS

Part Number	<b>4456</b>	
	<b>flat surface</b>	
	4-way entry	
Exterior Dimensions	length	56"/1422 mm
	width	44"/1118 mm
	height	4.4"/111 mm
Load Capacity	Static	30,000 lb/13607 kg
	Dynamic	4000 lb/1814kg
Tare Weight (may vary)	51 lb/23.2 kg	
Truckload Quantity	48'	528
	53'	550
Design/Construction	One-piece	

The **4456 Bulk Pallet's** design incorporates *Smart Deck Technology™* to create a flat, smooth surface that resists deflection and warping. Sloped lip transitions ensure leg and leg strap integrity.

Additionally, the 4456 Bulk Pallet's hygienic, flow-through deck design means that surface openings are perfectly aligned to underside openings. This allows both contaminants and wash water to easily fall through the openings, rather than collect on surfaces, for a bacteria-free, fast-drying pallet.

The 4456 Bulk Pallet has been approved by the FDA as meeting sanitary requirements for packaging handling in food and beverage applications.

Please call Customer Service at 1.800.442.4892 for more information.

All dimensions and specifications are approximate. Performance characteristics are based on uniform static loads and may be affected by concentrated loads and elevated temperatures. Materials and workmanship guaranteed for 3 years. Material: High Density Polyethylene.

# ROPAK™ Ordering and Accessories

## customize your container system

### How to build your unique ROPAK Reusable Container

1. Select your container footprint and height.
2. Select your choice of drop door options—most containers offer up to 4 drop doors.
3. Customize your container by selecting from a variety of label options and colors.
4. Add accessories to further customize your ROPAK container.

### Label Configuration Options Example

23

**LONG SIDE A W/DD**

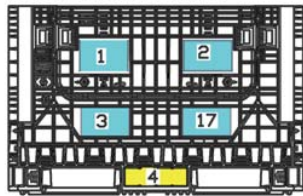

**LONG SIDE A SOLID**

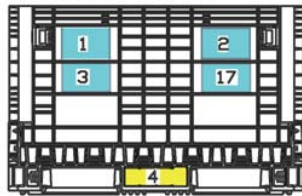

**LONG SIDE B W/DD**

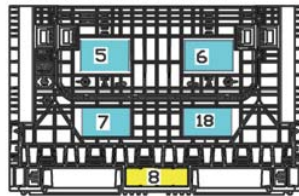

**LONG SIDE B SOLID**

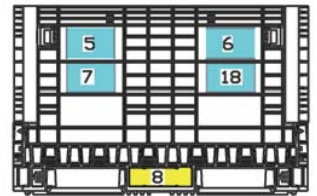

### Label Style Options

Not all labels are available on all containers. Please call Customer Service at 1.800.442.4892 for specific options.



Flat panel label areas – Molded into most ROPAK container sidewalls



Card holder label – Snaps onto container



Label placard adhesive sticker/cards (Kennedy process releasable surface)



Releasable Surface label areas – Molded into ROPAK container sidewalls



KanBan label – Snaps onto container

Continued...

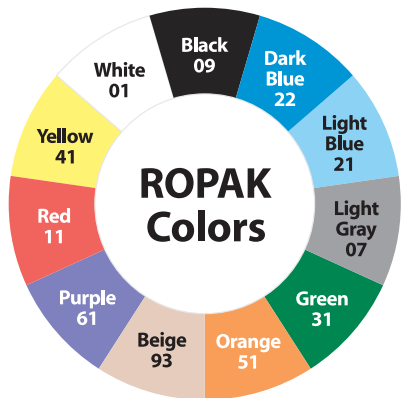

### Color Options

ROPAK containers are available in a variety of colors. Minimum quantities and an upcharge may be required for colors other than black. Please note, these color swatches are only a representation of injection-molded resins. Actual ROPAK product color may vary due to both material and this catalog's printing process.

### Identification Plate Options

Identification plates are available with your text, logo and barcode. Available in 11 background colors and one or two imprint colors. Containers can also be equipped with passive or active RFID tags.



### Covers: Accessory Available in a Variety of Styles

#### HDPE COVER SPECIFICATIONS\*

Part Number	3230	4048	4548
Exterior Dimensions			
length	31.0"/787 mm	40.2"/1021 mm	45.9"/1166 mm
width	33.0"/838 mm	48.1"/1222 mm	48.9"/1242 mm
height to surface	3.0"/76 mm	3.0"/76 mm	3.0"/76 mm
Stack Interlock Height	0.7"/18 mm	0.7"/18 mm	0.7"/18 mm
Total Height	3.7"/94 mm	3.7"/94 mm	3.7"/94 mm
Interior Dimensions			
length	30.5"/775 mm	39.6"/1006 mm	45.4"/1153 mm
width	32.4"/823 mm	47.6"/1209 mm	48.4"/1229 mm
height	1.9"/48 mm	1.9"/48 mm	1.9"/48 mm
Tare Weight (may vary)	11 lb/5 kg	23 lb/10.4 kg	27 lb/12.3 kg

\*All dimensions and weights are approximate.

Fabricated covers are available for 5648, 6448, 7048, and 7848 containers. Vacuum-formed covers are also available for 4548 and 6448 containers.

### Slip Sheet Accessories

Durable, smooth slip sheets are used to separate and protect your product layers and close the open-grid pallet base. They are available for the 3230, 4048, and 4548 models, loose or attached.

### Quick Release Rod Accessories

Removable, Quick Release Rods allow operators to completely remove a sidewall to gain access to the container's interior in situations where the drop door is not big enough. Rods are available for 4048 (48" side); 4548 25"-34" heights (48" side); and all Extended Length containers (48" side).

